



SAGE 300™ SERIES THERMAL MASS FLOW METERS

SAGE 300™ THERMAL MASS FLOW METERS

The Sage 300 Series of products are the economical alternative to Sage's flagship product, the Prime™. These products offer the same level of performance as the Prime with fewer features. The units are agency approved for use in Class I, Division 2 hazardous areas and are CE approved. The 300 series is available with 24 VDC or 115/230 VAC input power. The power dissipation is under 2.5 watts which is the lowest in the industry. These units offer both a 4-20 mA signal and pulsed output of total flow. In addition, Modbus RTU with RS-485 communication is optional and provides both daisy chain communication and the ability to reconfigure the operating parameters of the instrument.

The Sage 300 meters are available with either integral or remote electronics. The remote design has lead-length compensation that permits cable lengths up to 1000 feet (300 meters) and uses a NEMA 4 and explosion-proof junction box. All meters can be used with either the ½" insertion probe in pipes 1" and larger or the in-line flow body with sizes from ¼" to 4". Various connections are available for inserting the probe into the pipe. *See reverse side for more information.*

The 300 is available with a display and window or as a blind version. The display provides the reading of flow rate, total flow and gas temperature.

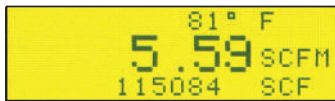

All units come calibrated from the Sage NIST traceable calibration facility and are preconfigured with the specified process and installation parameters for the application.

Sage's unique In-Situ calibration verification procedure is available only on the Sage Prime.

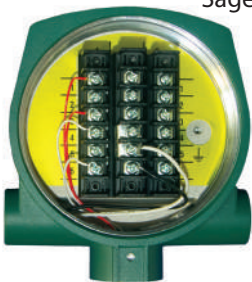

As the Sage Prime, the 300 Series uses a two compartment compact housing with a separate wiring section containing large, easy to access terminals to simplify field installation.

SPECIFICATIONS

Performance:

Accuracy: +/- 1% of reading plus 0.5% of full scale

Repeatability: 0.2% of reading

Low End Sensitivity: 5 SFPM (1 SCFM in 6" pipe)

Response Time: 1 second time constant

Turndown: 100:1

Resolution: 1000:1

Electronics:

Power: 24 +/- 10% VDC or 90 – 265 VAC

Output: 4-20 mA

Pulse: Solid State

Isolated: External powered 4-20 and pulse

Modbus: RS 485 RTU optional¹

Approvals: Class I, Division 2, NEMA 4, CE

Ambient Temperature: -40 to 150° F (-40 to 65° C)

Sensor:

Type: Insertion probe (1/2" diameter)

Flow Body with flow conditioning (1/4" to 4")

Materials: 316 stainless steel and Hastelloy C

Process Temperature Range: -40 to 450° F (-40 to 230° C)

Process Pressure: Max 500 psig

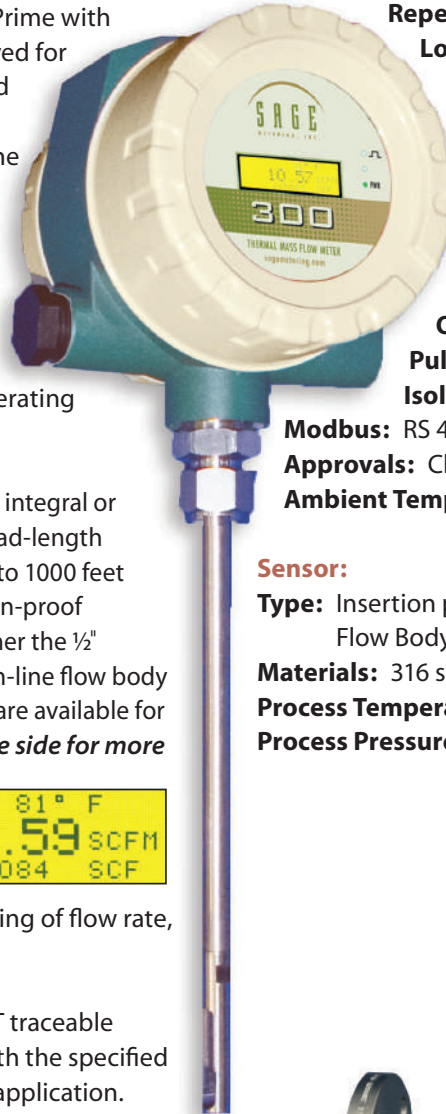

Sage 300 shown with in-line, flanged flow body with sizes from ¼" to 4".

¹ Modbus required for configuration of instrument. Sage Addresser software available.

FLOW SIZING

The Sage thermal mass flow meters can be used for essentially any gas, but the sizing will vary for different gas types. The two most common gases Sage flow meters are used for are air and natural gas. The following charts provide the maximum

flow rates for these gases in various pipe sizes. For flow rate of other gases, consult Sage Metering or visit the **Build a Meter** section at: sagemetering.com/build-a-meter

Sizing Chart – Air

MAXIMUM FLOW RATE

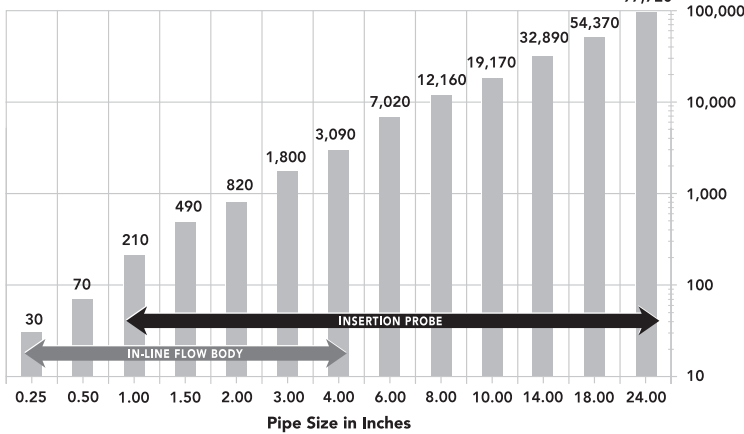

Sizing Chart – Natural Gas

MAXIMUM FLOW RATE

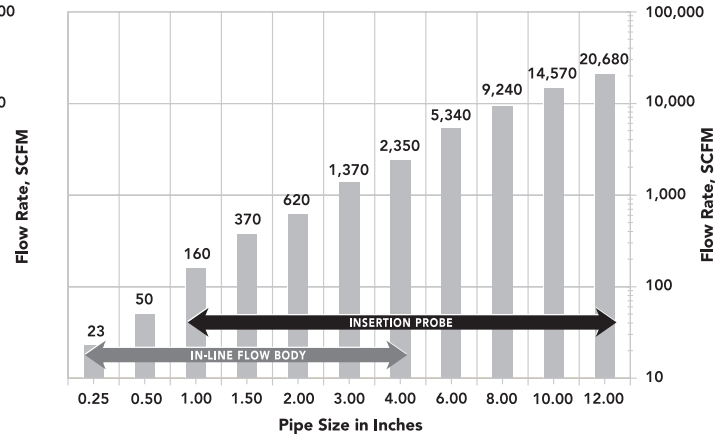

FITTINGS AND PROBE LENGTH

Sage can provide different fittings for inserting the probe into the pipe. The most popular are the simple low-pressure valve and compression fitting (SVA05LP) and the high-pressure valve and fitting with safety cable (SVA05). Refer to the table for recommended probe lengths for each fitting for various pipe sizes.

Probe Length of Insertion Probes

PIPE SIZE	STCF05 Compression Fitting	SVA05LP Isolation Valve Low Pressure	SVA05 Isolation Valve High Pressure
	<125 PSIG	<50 PSIG	<250 PSIG
1" – 3.5"	6"	12"	15"
4" – 12"	12"	15"	18"
14" – 24"	15"	18"	24"
30"	18"	24"	30"
36"	24"	30"	36"

FLOW CONDITIONING

When using an insertion probe, the accuracy is dependent on the flow profile in the pipe. The desired flow profile naturally develops with sufficient straight run of the pipe. In cases where there is insufficient straight run, Sage Metering provides flow conditioning elements that insert into the pipe.

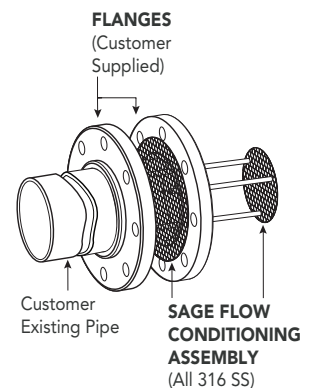

DIMENSIONS

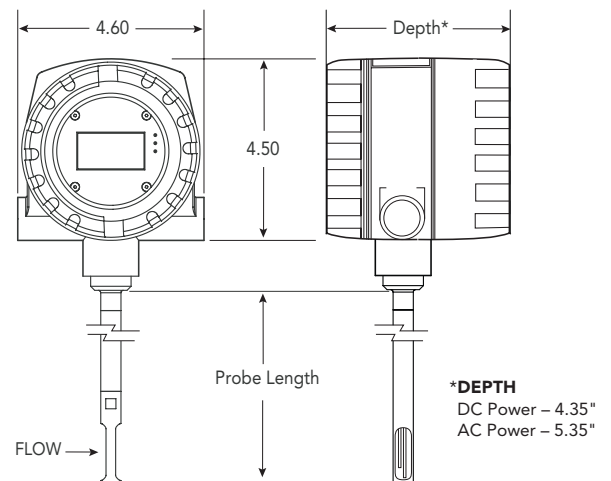

MODEL NUMBER BREAKDOWN

Model	Display	Electronics	Probe Size	Probe Length	Power	Gas Type	+	Mounting Hardware
3 = 300 Series	0=Yes 1=No	1=Integral 2=Remote	05=1/2"	See Table	DC24 AC115 AC230	Specify Gas		SVA05 SVA05LP STCF05

Example
301-05-18-DC24-AIR

Sage Metering, Inc. / 8 Harris Court / Bldg D-1 / Monterey, CA 93940 / 866-677-SAGE (7243) / 831-242-2030 / Fax 831-655-4965 / www.sagemetering.com